









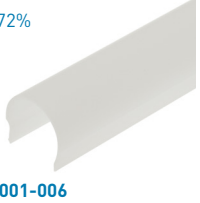
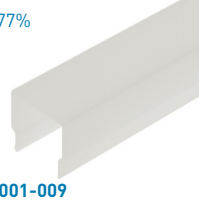

# LED Profil LBU | max. LED Leistung pro Meter: 18W → Flexstrip 80

| ALUMINIUM PROFILE & ABDECKUNGEN   ALUMINIUM PROFILES & COVERS   |  |
|---|--|
|  <p><b>AP-001-004</b><br/>Aluminium Profil LBU<br/>Aluminium profile LBU</p> |  <p><b>AB-001-100</b><br/>Aluminium Abdeckung LB<br/>Aluminium cover LB</p> |

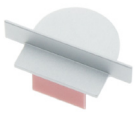
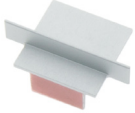
| PROFIL ABDECKUNGEN UND EINSCHÜBE   PROFILE COVERS AND INSETS  |   |   |
|---|---|---|
| <p><math>\eta \approx 88\%</math></p>  <p><b>AB-001-001</b><br/>PMMA Abdeckung LB Flach Transparent<br/>PMMA cover LB flat transparent</p> | <p><math>\eta \approx 66\%</math></p>  <p><b>AB-001-003</b><br/>PMMA Abdeckung LB Flach Opal<br/>PMMA cover LB flat milky</p>    | <p><math>\eta \approx 84\%</math></p>  <p><b>AB-001-010</b><br/>PMMA Abdeckung LB engstrahlend - Abstrahlwinkel 64°<br/>PMMA cover LB narrow beam - beam angle 64°</p>   |
| <p><math>\eta \approx 72\%</math></p>  <p><b>AB-001-006</b><br/>PMMA Abdeckung LB Rund opal<br/>PMMA cover LB round milky</p>             | <p><math>\eta \approx 77\%</math></p>  <p><b>AB-001-009</b><br/>PMMA Abdeckung LB Eckig Opal<br/>PMMA cover LB square milky</p> | <p><math>\eta \approx 83\%</math></p>  <p><b>AB-001-011</b><br/>PMMA Abdeckung LB asymmetrisch - Abstrahlwinkel 73°<br/>PMMA cover LB asymmetrical - beam angle 73°</p> |

| PROFIL ENDKAPPEN   PROFILE ENDCAPS  |   |   |
|---|---|---|
| <p>Endkappenstärke   End cap thickness 1,0mm</p>  <p><b>EK-001-400</b><br/>Profil Endkappe LBU Flach geschlossen<br/>Profile endcap LBU flat closed</p>            | <p>Endkappenstärke   End cap thickness 1,0mm</p>  <p><b>EK-001-410</b><br/>Profil Endkappe LBU Rund geschlossen<br/>Profile endcap LBU round closed</p>            | <p>Endkappenstärke   End cap thickness 1,0mm</p>  <p><b>EK-001-420</b><br/>Profil Endkappe LBU Eckig geschlossen<br/>Profile endcap LBU square closed</p>            |
| <p>Endkappenstärke   End cap thickness 1,0mm</p>  <p><b>EK-001-401</b><br/>Profil Endkappe LBU Flach mit Langloch<br/>Profile endcap LBU flat with cable entry</p> | <p>Endkappenstärke   End cap thickness 1,0mm</p>  <p><b>EK-001-411</b><br/>Profil Endkappe LBU Rund mit Langloch<br/>Profile endcap LBU round with cable entry</p> | <p>Endkappenstärke   End cap thickness 1,0mm</p>  <p><b>EK-001-421</b><br/>Profil Endkappe LBU Eckig mit Langloch<br/>Profile endcap LBU square with cable entry</p> |

|    |    |    |              |                |
|----|----|----|--------------|----------------|
| 1m | 2m | 4m | SONDER LÄNGE | SPECIAL LENGTH |
|----|----|----|--------------|----------------|



STANDARDLÄNGE = 2M | ALLE ANDEREN LÄNGEN SIND VOM UMTAUSCH UND DER RÜCKGABE AUSGESCHLOSSEN. LÄNGEN ÜBER 2M WERDEN MITTELS SPEDITION VERSENDET UND ERFORDERN EINE MINDESTBESTELLMENGE VON 10 STK.



STANDARD LENGTH = 2M | ALL OTHER LENGTHS ARE EXCLUDED FROM EXCHANGE AND RETURN. LENGTHS OVER 2M ARE SHIPPED BY FREIGHT CARRIER AND REQUIRE A MINIMUM ORDER QUANTITY OF 10 PCS.

## HINWEIS PLEASE NOTE

Kunststoff und Aluminium besitzen unterschiedliche Ausdehnungskoeffizienten, welche bei der Montage zu berücksichtigen sind. Ausgehend von 20°C verändert sich die Länge beim Aluminium um ca. 0,25mm pro Meter und beim Kunststoff um ca. 0,70mm pro Meter je 10°C Temperaturunterschied.

Plastic and aluminium have different expansion coefficients, which must be considered during assembly. Based on 20°C the length of aluminium changes approximately 0,25mm per meter and plastic approximately 0,70 mm per meter per 10°C of difference in temperature.

| PROFIL ZUBEHÖR   PROFILE ACCESSORIES   |  |
|--|--|
|         |         |
| <p><b>PZ-003-001</b><br/>Einbau Montagewinkel LB und TB<br/>Mounting angle LB and TB</p> | <p><b>PZ-008-001</b><br/>Einbau Montagefeder LB und TB<br/>Mounting spring LB and TB</p> |

| LBU PROFIL BESTÜCKT MIT FLEXSTRIP 36 RGB MIT EINEM LED ABSTAND VON 33MM IN KOMBINATION MIT DEN UNTERSCHIEDLICHEN ABDECKUNGEN<br>LBU PROFILE FITTED WITH FLEXSTRIP 36 RGB WITH A LED DISTANCE OF 33MM IN COMBINATION WITH THE DIFFERENT COVERS                 |  |  |
|---|--|--|
| <p>PMMA Abdeckung<br/>LB Flach Transparent<br/>91% Transmission</p>   | <p>PMMA Abdeckung<br/>LB Flach Opal<br/>50% Transmission</p> | <p>PMMA Abdeckung<br/>LB Eckig Opal<br/>50% Transmission</p> |
|    |  |  |
| <p>PMMA cover<br/>LB flat transparent<br/>91% transmission</p>  | <p>PMMA cover<br/>LB flat milky<br/>50% transmission</p>     | <p>PMMA cover<br/>LB square milky<br/>50% transmission</p>   |
| LBU PROFIL BESTÜCKT MIT FLEXSTRIP 72 MIT EINEM LED ABSTAND VON 16,5MM IN KOMBINATION MIT DEN UNTERSCHIEDLICHEN ABDECKUNGEN<br>LBU PROFILE FITTED WITH FLEXSTRIP 72 WITH A LED DISTANCE OF 16.5MM IN COMBINATION WITH THE DIFFERENT COVERS                     |  |  |
| <p>PMMA Abdeckung<br/>LB Flach Transparent<br/>91% Transmission</p>   | <p>PMMA Abdeckung<br/>LB Flach Opal<br/>50% Transmission</p> | <p>PMMA Abdeckung<br/>LB Eckig Opal<br/>50% Transmission</p> |
|    |  |  |
| <p>PMMA cover<br/>LB flat transparent<br/>91% transmission</p>  | <p>PMMA cover<br/>LB flat milky<br/>50% transmission</p>     | <p>PMMA cover<br/>LB square milky<br/>50% transmission</p>   |
| LBU PROFIL BESTÜCKT MIT FLEXSTRIP 48 ODER 72 DW MIT EINEM LED ABSTAND VON 7,15MM IN KOMBINATION MIT DEN UNTERSCHIEDLICHEN ABDECKUNGEN<br>LBU PROFILE FITTED WITH FLEXSTRIP 48 OR 72 DW WITH A LED DISTANCE OF 7.15MM IN COMBINATION WITH THE DIFFERENT COVERS |  |  |
| <p>PMMA Abdeckung<br/>LB Flach Transparent<br/>91% Transmission</p>   | <p>PMMA Abdeckung<br/>LB Flach Opal<br/>50% Transmission</p> | <p>PMMA Abdeckung<br/>LB Eckig Opal<br/>50% Transmission</p> |
|    |  |  |
| <p>PMMA cover<br/>LB flat transparent<br/>91% transmission</p>  | <p>PMMA cover<br/>LB flat milky<br/>50% transmission</p>     | <p>PMMA cover<br/>LB square milky<br/>50% transmission</p>   |