

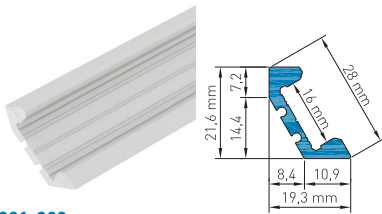

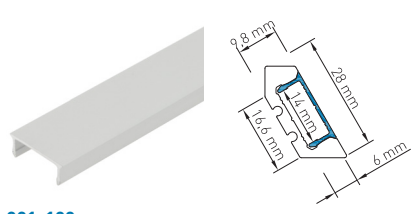

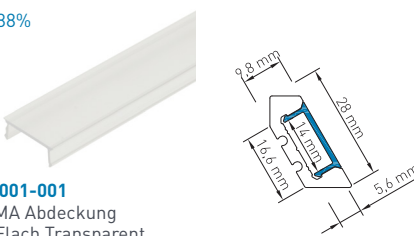
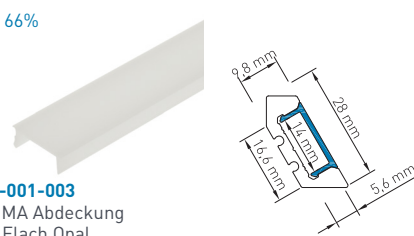
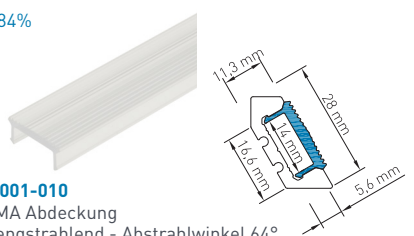
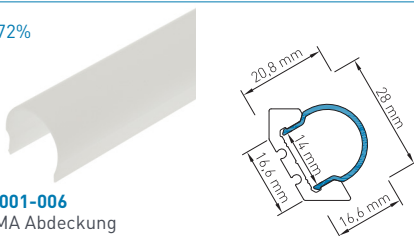
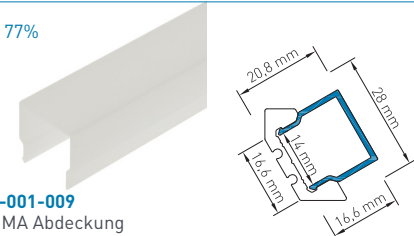
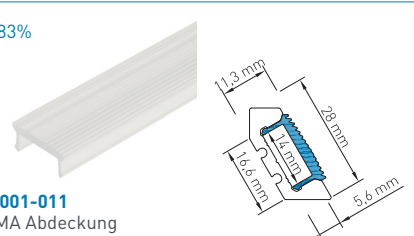

LED Profil LBE 30/60 | max. LED Leistung pro Meter: 24W → Flexstrip 108

ALUMINIUM PROFILE & ABDECKUNGEN ALUMINIUM PROFILES & COVERS	
 <p>AP-001-008 Aluminium Profil LBE 30/60 Aluminium profile LBE 30/60</p>	 <p>AB-001-100 Aluminium Abdeckung LB Aluminium cover LB</p>

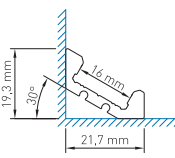
PROFIL ABDECKUNGEN UND EINSCHÜBE PROFILE COVERS AND INSETS		
<p>$\eta \approx 88\%$</p>  <p>AB-001-001 PMMA Abdeckung LB Flach Transparent PMMA cover LB flat transparent</p>	<p>$\eta \approx 66\%$</p>  <p>AB-001-003 PMMA Abdeckung LB Flach Opal PMMA cover LB flat milky</p>	<p>$\eta \approx 84\%$</p>  <p>AB-001-010 PMMA Abdeckung LB engstrahlend - Abstrahlwinkel 64° PMMA cover LB narrow beam - beam angle 64°</p>
<p>$\eta \approx 72\%$</p>  <p>AB-001-006 PMMA Abdeckung LB Rund opal PMMA cover LB round milky</p>	<p>$\eta \approx 77\%$</p>  <p>AB-001-009 PMMA Abdeckung LB Eckig Opal PMMA cover LB square milky</p>	<p>$\eta \approx 83\%$</p>  <p>AB-001-011 PMMA Abdeckung LB asymmetrisch - Abstrahlwinkel 73° PMMA cover LB asymmetrical - beam angle 73°</p>

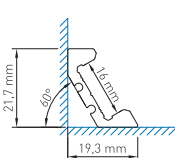
PROFIL ENDKAPPEN PROFILE ENDCAPS	ANWENDUNGSBEISPIELE 30 UND 60 GRAD APPLICATION EXAMPLES 30 AND 60 DEGREES	
<p>Endkappenstärke End cap thickness 2,5mm</p>  <p>EK-001-800 Profil Endkappe LBE 30/60 Flach geschlossen Profile endcap LBE 30/60 flat closed</p>	 <p>Montage 30 Grad Profil kleben oder bohren Mounting 30 degrees profile stick or drill</p>	 <p>Beispielfoto Example image : Profil + Endkappen + Abdeckung Montage 30 Grad Profile + end caps + cover mounting 30 degrees</p>
<p>Endkappenstärke End cap thickness 2,5mm</p>  <p>EK-001-801 Profil Endkappe LBE 30/60 Flach mit Langloch Profile endcap LBE 30/60 flat with cable entry</p>	 <p>Montage 60 Grad Profil kleben oder bohren Mounting 60 degrees profile stick or drill</p>	 <p>Beispielfoto Example image : Profil + Endkappen + Abdeckung Montage 60 Grad Profile + end caps + cover mounting 60 degrees</p>

1m	2m	4m	SONDER LÄNGE	SPECIAL LENGTH
----	----	----	--------------	----------------

STANDARDLÄNGE = 2M | ALLE ANDEREN LÄNGEN SIND VOM UMTAUSCH UND DER RÜCKGABE AUSGESCHLOSSEN. LÄNGEN ÜBER 2M WERDEN MITTELS SPEDITION VERSENDET UND ERFORDERN EINE MINDESTBESTELLMENGE VON 10 STK.

STANDARD LENGTH = 2M | ALL OTHER LENGTHS ARE EXCLUDED FROM EXCHANGE AND RETURN. LENGTHS OVER 2M ARE SHIPPED BY FREIGHT CARRIER AND REQUIRE A MINIMUM ORDER QUANTITY OF 10 PCS.

HINWEIS PLEASE NOTE

Kunststoff und Aluminium besitzen unterschiedliche Ausdehnungskoeffizienten, welche bei der Montage zu berücksichtigen sind. Ausgehend von 20°C verändert sich die Länge beim Aluminium um ca. 0,25mm pro Meter und beim Kunststoff um ca. 0,70mm pro Meter je 10°C Temperaturunterschied.

Plastic and aluminium have different expansion coefficients, which must be considered during assembly. Based on 20°C the length of aluminium changes approximately 0,25 mm per meter and plastic approximately 0,70 mm per meter per 10°C of difference in temperature.

PROFIL ZUBEHÖR | PROFILE ACCESSORIES



EK-100-002

Torx Bit TX8 für Endkappenschrauben
Torx Bit TX8 for endcap screws

LBE 30/60 PROFIL BESTÜCKT MIT FLEXSTRIP 36 RGB MIT EINEM LED ABSTAND VON 33MM IN KOMBINATION MIT DEN UNTERSCHIEDLICHEN ABDECKUNGEN

LBE 30/60 PROFILE FITTED WITH FLEXSTRIP 36 RGB WITH A LED DISTANCE OF 33MM IN COMBINATION WITH THE DIFFERENT COVERS

PMMA Abdeckung
LB Flach Transparent
91% Transmission

PMMA Abdeckung
LB Flach Opal
50% Transmission

PMMA Abdeckung
LB Eckig Opal
50% Transmission



PMMA cover
LB flat transparent
91% transmission

PMMA cover
LB flat milky
50% transmission

PMMA cover
LB square milky
50% transmission

LBE 30/60 PROFIL BESTÜCKT MIT FLEXSTRIP 72 MIT EINEM LED ABSTAND VON 16,5MM IN KOMBINATION MIT DEN UNTERSCHIEDLICHEN ABDECKUNGEN

LBE 30/60 PROFILE FITTED WITH FLEXSTRIP 72 WITH A LED DISTANCE OF 16.5MM IN COMBINATION WITH THE DIFFERENT COVERS

PMMA Abdeckung
LB Flach Transparent
91% Transmission

PMMA Abdeckung
LB Flach Opal
50% Transmission

PMMA Abdeckung
LB Eckig Opal
50% Transmission



PMMA cover
LB flat transparent
91% transmission

PMMA cover
LB flat milky
50% transmission

PMMA cover
LB square milky
50% transmission

LBE 30/60 PROFIL BESTÜCKT MIT FLEXSTRIP 48 ODER 72 DW MIT EINEM LED ABSTAND VON 7,15MM IN KOMBINATION MIT DEN UNTERSCH. ABDECKUNGEN

LBE 30/60 PROFILE FITTED WITH FLEXSTRIP 48 OR 72 DW WITH A LED DISTANCE OF 7.15MM IN COMBINATION WITH THE DIFFERENT COVERS

PMMA Abdeckung
LB Flach Transparent
91% Transmission

PMMA Abdeckung
LB Flach Opal
50% Transmission

PMMA Abdeckung
LB Eckig Opal
50% Transmission



PMMA cover
LB flat transparent
91% transmission

PMMA cover
LB flat milky
50% transmission

PMMA cover
LB square milky
50% transmission