

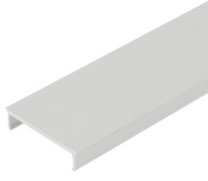







ALUMINIUM PROFILE & ABDECKUNGEN ALUMINIUM PROFILES & COVERS	
 <p>AP-006-005 Aluminium Profil CLW Aluminium profile CLW</p>	 <p>oben, vorne oder unten top, front or down</p> <p>AB-006-100 Aluminium Abdeckung CL Aluminium cover CL</p>

PROFIL ABDECKUNGEN UND EINSCHÜBE PROFILE COVERS AND INSETS			
<p>$\eta \approx 65\%$ oben oder unten top or down $\eta \approx 55\%$ vorne front</p>  <p>AB-006-001 PMMA Abdeckung CL Flach Transparent PMMA cover CL flat transparent</p>	<p>$\eta \approx 53\%$ oben oder unten top or down $\eta \approx 43\%$ vorne front</p>  <p>AB-006-003 PMMA Abdeckung CL Flach Opal PMMA cover CL flat milky</p>	<p>$\eta \approx 55\%$ oben oder unten top or down $\eta \approx 46\%$ vorne front</p>  <p>MP-006-001 Mikroprismatischer Einschub CL Transparent Microprismatic Inset CL transparent</p>	  
<p>$\eta \approx 58\%$ oben oder unten top or down</p>  <p>AB-006-006 PMMA Abdeckung CL Rund opal PMMA cover CL round milky</p>	<p>$\eta \approx 56\%$ oben oder unten top or down</p>  <p>AB-006-009 PMMA Abdeckung CL Eckig Opal PMMA cover CL square milky</p>	<p>$\eta \approx 52\%$ oben oder unten top or down $\eta \approx 44\%$ vorne front</p>  <p>MP-006-003 Mikroprismatischer Einschub CL Opal Microprismatic Inset CL milky</p>	  

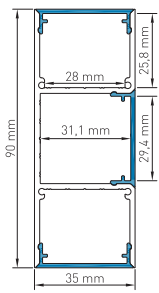
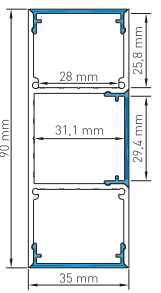
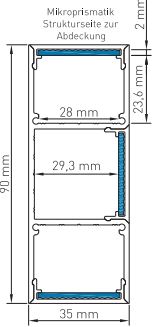
PROFIL ENDKAPPEN PROFILE ENDCAPS		
<p>Endkappenstärke End cap thickness 2,5mm</p>  <p>EK-006-500 Profil Endkappe CLW Flach geschlossen Profile endcap CLW flat closed</p>	<p>Endkappenstärke End cap thickness 2,5mm</p>  <p>EK-006-510 Profil Endkappe CLW Rund geschlossen Profile endcap CLW round closed</p>	<p>Endkappenstärke End cap thickness 2,5mm</p>  <p>EK-006-520 Profil Endkappe CLW Eckig geschlossen Profile endcap CLW square closed</p>

1m	2m	4m	SONDER LÄNGE	SPECIAL LENGTH
----	----	----	--------------	----------------

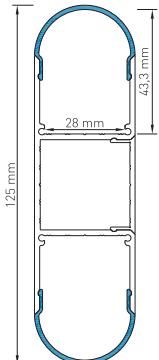
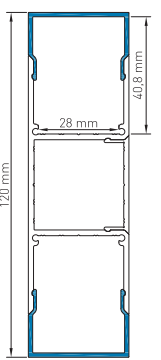
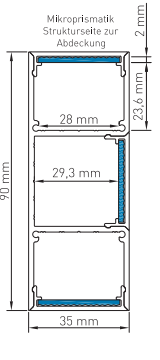
STANDARDLÄNGE = 2M | ALLE ANDEREN LÄNGEN SIND VOM UMTAUSCH UND DER RÜCKGABE AUSGESCHLOSSEN. LÄNGEN ÜBER 2M WERDEN MITTELS SPEDITION VERSENDET UND ERFORDERN EINE MINDESTBESTELLMENGE VON 10 STK.

STANDARD LENGTH = 2M | ALL OTHER LENGTHS ARE EXCLUDED FROM EXCHANGE AND RETURN. LENGTHS OVER 2M ARE SHIPPED BY FREIGHT CARRIER AND REQUIRE A MINIMUM ORDER QUANTITY OF 10 PCS.

HINWEIS PLEASE NOTE

Kunststoff und Aluminium besitzen unterschiedliche Ausdehnungskoeffizienten, welche bei der Montage zu berücksichtigen sind. Ausgehend von 20°C verändert sich die Länge beim Aluminium um ca. 0,25mm pro Meter und beim Kunststoff um ca. 0,70mm pro Meter je 10°C Temperaturunterschied.

Plastic and aluminium have different expansion coefficients, which must be considered during assembly. Based on 20°C the length of aluminium changes approximately 0,25mm per meter and plastic approximately 0,70 mm per meter per 10°C of difference in temperature.

PROFIL ZUBEHÖR | PROFILE ACCESSORIES



PZ-001-002
Seilabhänger 2m
inkl. Deckenbefestigung
Wire suspension 2m
incl. ceiling fixture

PZ-001-005
Seilabhänger 5m
inkl. Deckenbefestigung
Wire suspension 5m
incl. ceiling fixture



PZ-002-001
Seilstopper inkl. M4 Senkkopfschraube
Wire stopper incl. M4 countersunk screw



EK-100-002
Torx Bit TX8 für Endkappenschrauben
Torx Bit TX8 for endcap screws



PZ-006-001
Saugnapf 30mm
Suction cup 30mm

