

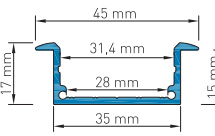



# LED Profil CLU | max. LED Leistung pro Meter: 38W → 1 x Flexstrip 160 oder 2 x Flexstrip 75

ALUMINIUM PROFILE & ABDECKUNGEN   ALUMINIUM PROFILES & COVERS	
  <p><b>AP-006-004</b> Aluminium Profil CLU Aluminium profile CLU</p>	  <p><b>AB-006-100</b> Aluminium Abdeckung CL Aluminium cover CL</p>

PROFIL ABDECKUNGEN UND EINSCHÜBE   PROFILE COVERS AND INSETS		
<p><math>\eta \approx 80\%</math></p>   <p><b>AB-006-001</b> PMMA Abdeckung CL Flach Transparent PMMA cover CL flat transparent</p>	<p><math>\eta \approx 66\%</math></p>   <p><b>AB-006-003</b> PMMA Abdeckung CL Flach Opal PMMA cover CL flat milky</p>	<p><math>\eta \approx 69\%</math></p> <p>Transparente Abdeckung erforderlich Transparent cover necessary</p>   <p><b>MP-006-001</b> Mikroprismatischer Einschub CL Transparent Microprismatic Inset CL transparent</p>
<p><math>\eta \approx 69\%</math></p>   <p><b>AB-006-006</b> PMMA Abdeckung CL Rund opal PMMA cover CL round milky</p>	<p><math>\eta \approx 72\%</math></p>   <p><b>AB-006-009</b> PMMA Abdeckung CL Eckig Opal PMMA cover CL square milky</p>	<p><math>\eta \approx 66\%</math></p> <p>Transparente Abdeckung erforderlich Transparent cover necessary</p>   <p><b>MP-006-003</b> Mikroprismatischer Einschub CL Opal Microprismatic Inset CL milky</p>

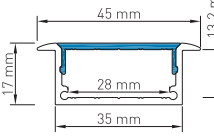
PROFIL ENDKAPPEN   PROFILE ENDCAPS		
<p>Endkappenstärke   End cap thickness 2,5mm</p>  <p><b>EK-006-400</b> Profil Endkappe CLU Flach geschlossen Profile endcap CLU flat closed</p>	<p>Endkappenstärke   End cap thickness 2,5mm</p>  <p><b>EK-006-410</b> Profil Endkappe CLU Rund geschlossen Profile endcap CLU round closed</p>	<p>Endkappenstärke   End cap thickness 2,5mm</p>  <p><b>EK-006-420</b> Profil Endkappe CLU Eckig geschlossen Profile endcap CLU square closed</p>
<p>Endkappenstärke   End cap thickness 2,5mm</p>  <p><b>EK-006-401</b> Profil Endkappe CLU Flach mit Langloch Profile endcap CLU flat with cable entry</p>	<p>Endkappenstärke   End cap thickness 2,5mm</p>  <p><b>EK-006-411</b> Profil Endkappe CLU Rund mit Langloch Profile endcap CLU round with cable entry</p>	<p>Endkappenstärke   End cap thickness 2,5mm</p>  <p><b>EK-006-421</b> Profil Endkappe CLU Eckig mit Langloch Profile endcap CLU square with cable entry</p>

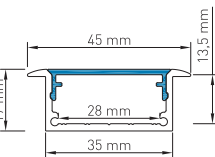
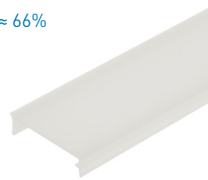
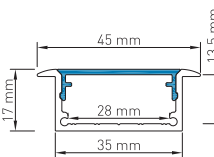
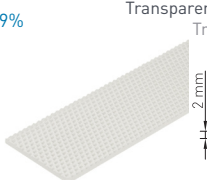
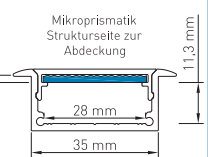
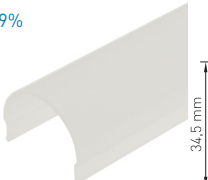
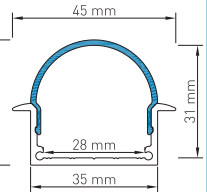
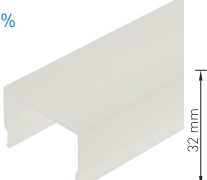
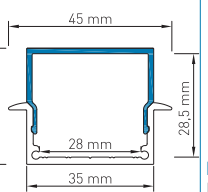
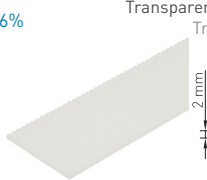
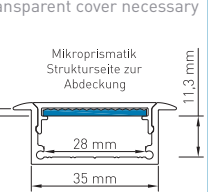
1m	2m	4m	SONDER LÄNGE	SPECIAL LENGTH
----	----	----	--------------	----------------

STANDARDLÄNGE = 2M | ALLE ANDEREN LÄNGEN SIND VOM UMTAUSCH UND DER RÜCKGABE AUSGESCHLOSSEN. LÄNGEN ÜBER 2M WERDEN MITTELS SPEDITION VERSENDET UND ERFORDERN EINE MINDESTBESTELLMENGE VON 10 STK.









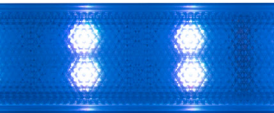

STANDARD LENGTH = 2M | ALL OTHER LENGTHS ARE EXCLUDED FROM EXCHANGE AND RETURN. LENGTHS OVER 2M ARE SHIPPED BY FREIGHT CARRIER AND REQUIRE A MINIMUM ORDER QUANTITY OF 10 PCS.

## HINWEIS PLEASE NOTE

Kunststoff und Aluminium besitzen unterschiedliche Ausdehnungskoeffizienten, welche bei der Montage zu berücksichtigen sind. Ausgehend von 20 °C verändert sich die Länge beim Aluminium um ca. 0,25mm pro Meter und beim Kunststoff um ca. 0,70mm pro Meter je 10 °C Temperaturunterschied.

Plastic and aluminium have different expansion coefficients, which must be considered during assembly. Based on 20 °C the length of aluminium changes approximately 0,25mm per meter and plastic approximately 0,70 mm per meter per 10 °C of difference in temperature.

PROFIL ZUBEHÖR   PROFILE ACCESSORIES		
 <p><b>PZ-003-007</b> Einbau Montagewinkel CL und LBKI Mounting angle CL and LBKI</p>	 <p><b>PZ-003-006</b> Einbau Montagewinkel CL Mounting angle CL</p>	 <p><b>EK-100-002</b> Torx Bit TX8 für Endkappenschrauben Torx Bit TX8 for endcap screws</p>
 <p><b>PZ-006-001</b> Saugnapf 30mm Suction cup 30mm</p>		

CLU PROFIL BESTÜCKT MIT 2 X FLEXSTRIP 36 RGB MIT EINEM LED ABSTAND VON 33MM IN KOMBINATION MIT DEN UNTERSCHIEDLICHEN ABDECKUNGEN				
CLU PROFILE FITTED WITH 2 X FLEXSTRIP 36 RGB WITH A LED DISTANCE OF 33MM IN COMBINATION WITH THE DIFFERENT COVERS				
PMMA Abdeckung CL Flach Transparent 91% Transmission	PMMA Abdeckung CL Flach Transp. 91% Transmission + Mikroprismatik Transp. 95% Transmission	PMMA Abdeckung CL Flach Transp. 91% Transmission + Mikroprismatik Opal 93% Transmission	PMMA Abdeckung CL Flach Opal 76% Transmission	PMMA Abdeckung CL Eckig Opal 76% Transmission
				
PMMA cover CL flat transparent 91% transmission	PMMA cover CL flat transparent 91% transmission + Microprismatic transparent 95% transmission	PMMA cover CL flat transparent 91% transmission + Microprismatic milky 93% transmission	PMMA cover CL flat milky 76% transmission	PMMA cover CL square milky 76% transmission
CLU PROFIL BESTÜCKT MIT 2 X FLEXSTRIP 72 MIT EINEM LED ABSTAND VON 16,5MM IN KOMBINATION MIT DEN UNTERSCHIEDLICHEN ABDECKUNGEN				
CLU PROFILE FITTED WITH 2 X FLEXSTRIP 72 WITH A LED DISTANCE OF 16,5MM IN COMBINATION WITH THE DIFFERENT COVERS				
PMMA Abdeckung CL Flach Transparent 91% Transmission	PMMA Abdeckung CL Flach Transp. 91% Transmission + Mikroprismatik Transp. 95% Transmission	PMMA Abdeckung CL Flach Transp. 91% Transmission + Mikroprismatik Opal 93% Transmission	PMMA Abdeckung CL Flach Opal 76% Transmission	PMMA Abdeckung CL Eckig Opal 76% Transmission
				
PMMA cover CL flat transparent 91% transmission	PMMA cover CL flat transparent 91% transmission + Microprismatic transparent 95% transmission	PMMA cover CL flat transparent 91% transmission + Microprismatic milky 93% transmission	PMMA cover CL flat milky 76% transmission	PMMA cover CL square milky 76% transmission
CLU PROFIL BESTÜCKT MIT 2 X FLEXSTRIP 48 ODER 72 DW MIT EINEM LED ABSTAND VON 7,15MM IN KOMBINATION MIT DEN UNTERSCHIEDLICHEN ABDECKUNGEN				
CLU PROFILE FITTED WITH 2 X FLEXSTRIP 48 OR 72 DW WITH A LED DISTANCE OF 7,15MM IN COMBINATION WITH THE DIFFERENT COVERS				
PMMA Abdeckung CL Flach Transparent 91% Transmission	PMMA Abdeckung CL Flach Transp. 91% Transmission + Mikroprismatik Transp. 95% Transmission	PMMA Abdeckung CL Flach Transp. 91% Transmission + Mikroprismatik Opal 93% Transmission	PMMA Abdeckung CL Flach Opal 76% Transmission	PMMA Abdeckung CL Eckig Opal 76% Transmission
				
PMMA cover CL flat transparent 91% transmission	PMMA cover CL flat transparent 91% transmission + Microprismatic transparent 95% transmission	PMMA cover CL flat transparent 91% transmission + Microprismatic milky 93% transmission	PMMA cover CL flat milky 76% transmission	PMMA cover CL square milky 76% transmission