

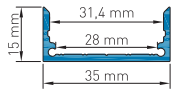





LED Profil CLF | max. LED Leistung pro Meter: 38W → 1 x Flexstrip 160 oder 2 x Flexstrip 75

ALUMINIUM PROFILE & ABDECKUNGEN ALUMINIUM PROFILES & COVERS	
  <p>AP-006-001 Natur eloxiert Natural anodized AP-006-101 Schwarz eloxiert Black anodized Aluminium Profil CLF Aluminium profile CLF</p>	  <p>AB-006-100 Aluminium Abdeckung CL Aluminium cover CL</p>

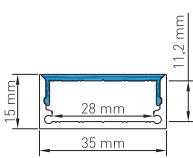
PROFIL ABDECKUNGEN UND EINSCHÜBE PROFILE COVERS AND INSETS		
<p>$\eta \approx 83\%$</p>   <p>AB-006-001 PMMA Abdeckung CL Flach Transparent PMMA cover CL flat transparent</p>	<p>$\eta \approx 69\%$</p>   <p>AB-006-003 PMMA Abdeckung CL Flach Opal PMMA cover CL flat milky</p>	<p>$\eta \approx 71\%$</p> <p>Transparente Abdeckung erforderlich Transparent cover necessary</p>   <p>MP-006-001 Mikroprismatischer Einschub CL Transparent Microprismatic Inset CL transparent</p>
<p>$\eta \approx 72\%$</p>   <p>AB-006-006 PMMA Abdeckung CL Rund opal PMMA cover CL round milky</p>	<p>$\eta \approx 75\%$</p>   <p>AB-006-009 PMMA Abdeckung CL Eckig Opal PMMA cover CL square milky</p>	<p>$\eta \approx 68\%$</p> <p>Transparente Abdeckung erforderlich Transparent cover necessary</p>   <p>MP-006-003 Mikroprismatischer Einschub CL Opal Microprismatic Inset CL milky</p>

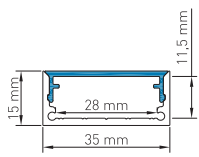
PROFIL ENDKAPPEN PROFILE ENDCAPS		
<p>Endkappenstärke End cap thickness 2,5mm</p>  <p>EK-006-100 Natur eloxiert Natural anodized EK-106-100 Schwarz eloxiert Black anodized Profil Endkappe CLF Flach geschlossen CLF flat closed</p>	<p>Endkappenstärke End cap thickness 2,5mm</p>  <p>EK-006-110 Profil Endkappe CLF Rund geschlossen Profile endcap CLF round closed</p>	<p>Endkappenstärke End cap thickness 2,5mm</p>  <p>EK-006-120 Profil Endkappe CLF Eckig geschlossen Profile endcap CLF square closed</p>
<p>Endkappenstärke End cap thickness 2,5mm</p>  <p>EK-006-101 Natur eloxiert Natural anodized EK-106-101 Schwarz eloxiert Black anodized CLF Flach mit Langloch CLF flat with cable entry</p>	<p>Endkappenstärke End cap thickness 2,5mm</p>  <p>EK-006-111 Profil Endkappe CLF Rund mit Langloch Profile endcap CLF round with cable entry</p>	<p>Endkappenstärke End cap thickness 2,5mm</p>  <p>EK-006-121 Profil Endkappe CLF Eckig mit Langloch Profile endcap CLF square with cable entry</p>

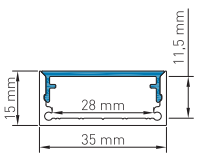
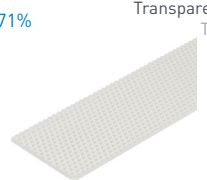
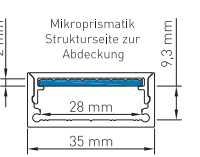
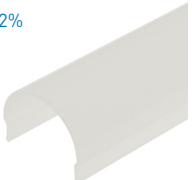
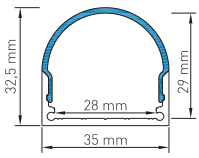
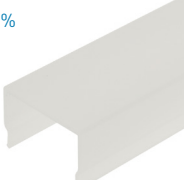
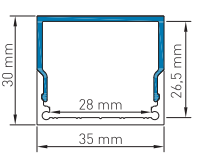
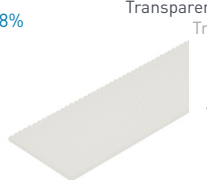
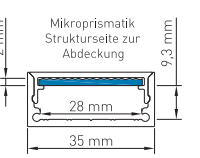
1m	2m	4m	SONDER LÄNGE	SPECIAL LENGTH
----	----	----	--------------	----------------

STANDARDLÄNGE = 2M | ALLE ANDEREN LÄNGEN SIND VOM UMTAUSCH UND DER RÜCKGABE AUSGESCHLOSSEN. LÄNGEN ÜBER 2M WERDEN MITTELS SPEDITION VERSENDET UND ERFORDERN EINE MINDESTBESTELLMENGE VON 10 STK.

STANDARD LENGTH = 2M | ALL OTHER LENGTHS ARE EXCLUDED FROM EXCHANGE AND RETURN. LENGTHS OVER 2M ARE SHIPPED BY FREIGHT CARRIER AND REQUIRE A MINIMUM ORDER QUANTITY OF 10 PCS.











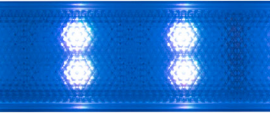

HINWEIS PLEASE NOTE

Kunststoff und Aluminium besitzen unterschiedliche Ausdehnungskoeffizienten, welche bei der Montage zu berücksichtigen sind. Ausgehend von 20°C verändert sich die Länge beim Aluminium um ca. 0,25mm pro Meter und beim Kunststoff um ca. 0,70mm pro Meter je 10°C Temperaturunterschied.

Plastic and aluminium have different expansion coefficients, which must be considered during assembly. Based on 20°C the length of aluminium changes approximately 0,25mm per meter and plastic approximately 0,70 mm per meter per 10°C of difference in temperature.

LED Profile CLF | max. LED power per meter: 38W → 1 x Flexstrip 160 or 2 x Flexstrip 75

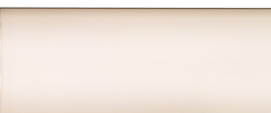
PROFIL ZUBEHÖR PROFILE ACCESSORIES		
 <p>PZ-001-002 Seilabhänger 2m inkl. Deckenbefestigung Wire suspension 2m incl. ceiling fixture</p> <p>PZ-001-005 Seilabhänger 5m inkl. Deckenbefestigung Wire suspension 5m incl. ceiling fixture</p>	 <p>PZ-002-001 Seilstopper inkl. M4 Senkkopfschraube Wire stopper incl. M4 countersunk screw</p>	 <p>PZ-005-004 Montage Clip CLF Mounting Clip CLF</p>
 <p>PZ-007-001 Montagewinkel schwenkbar Mounting angle swivelling</p>	 <p>EK-100-002 Torx Bit TX8 für Endkappenschrauben Torx Bit TX8 for endcap screws</p>	 <p>PZ-006-001 Saugnapf 30mm Suction cup 30mm</p>

CLF PROFIL BESTÜCKT MIT 2 X FLEXSTRIP 36 RGB MIT EINEM LED ABSTAND VON 33MM IN KOMBINATION MIT DEN UNTERSCHIEDLICHEN ABDECKUNGEN CLF PROFILE FITTED WITH 2 X FLEXSTRIP 36 RGB WITH A LED DISTANCE OF 33MM IN COMBINATION WITH THE DIFFERENT COVERS				
PMMA Abdeckung CL Flach Transparent 91% Transmission	PMMA Abdeckung CL Flach Transp. 91% Transmission + Mikroprismatik Transp. 95% Transmission	PMMA Abdeckung CL Flach Transp. 91% Transmission + Mikroprismatik Opal 93% Transmission	PMMA Abdeckung CL Flach Opal 76% Transmission	PMMA Abdeckung CL Eckig Opal 76% Transmission
				
PMMA cover CL flat transparent 91% transmission	PMMA cover CL flat transparent 91% transmission + Microprismatic transparent 95% transmission	PMMA cover CL flat transparent 91% transmission + Microprismatic milky 93% transmission	PMMA cover CL flat milky 76% transmission	PMMA cover CL square milky 76% transmission
CLF PROFIL BESTÜCKT MIT 2 X FLEXSTRIP 72 MIT EINEM LED ABSTAND VON 16,5MM IN KOMBINATION MIT DEN UNTERSCHIEDLICHEN ABDECKUNGEN CLF PROFILE FITTED WITH 2 X FLEXSTRIP 72 WITH A LED DISTANCE OF 16,5MM IN COMBINATION WITH THE DIFFERENT COVERS				
PMMA Abdeckung CL Flach Transparent 91% Transmission	PMMA Abdeckung CL Flach Transp. 91% Transmission + Mikroprismatik Transp. 95% Transmission	PMMA Abdeckung CL Flach Transp. 91% Transmission + Mikroprismatik Opal 93% Transmission	PMMA Abdeckung CL Flach Opal 76% Transmission	PMMA Abdeckung CL Eckig Opal 76% Transmission
				
PMMA cover CL flat transparent 91% transmission	PMMA cover CL flat transparent 91% transmission + Microprismatic transparent 95% transmission	PMMA cover CL flat transparent 91% transmission + Microprismatic milky 93% transmission	PMMA cover CL flat milky 76% transmission	PMMA cover CL square milky 76% transmission
CLF PROFIL BESTÜCKT MIT 2 X FLEXSTRIP 48 ODER 72 DW MIT EINEM LED ABSTAND VON 7,15MM IN KOMBINATION MIT DEN UNTERSCHIEDLICHEN ABDECKUNGEN CLF PROFILE FITTED WITH 2 X FLEXSTRIP 48 OR 72 DW WITH A LED DISTANCE OF 7,15MM IN COMBINATION WITH THE DIFFERENT COVERS				
PMMA Abdeckung CL Flach Transparent 91% Transmission	PMMA Abdeckung CL Flach Transp. 91% Transmission + Mikroprismatik Transp. 95% Transmission	PMMA Abdeckung CL Flach Transp. 91% Transmission + Mikroprismatik Opal 93% Transmission	PMMA Abdeckung CL Flach Opal 76% Transmission	PMMA Abdeckung CL Eckig Opal 76% Transmission
				
PMMA cover CL flat transparent 91% transmission	PMMA cover CL flat transparent 91% transmission + Microprismatic transparent 95% transmission	PMMA cover CL flat transparent 91% transmission + Microprismatic milky 93% transmission	PMMA cover CL flat milky 76% transmission	PMMA cover CL square milky 76% transmission