

LED RF & DMX WiFi Interface Ethernet - User Manual



Item no: LC-012-000

1. Product Description

The RF & DMX Wifi Interface Ethernet works with RF-receiver series or DMX 512 decoders to be controlled by iOS or Android system via WiFi. With the interface you can control via WIFI upto 8 different zones.

2. Specification

Operation Voltage: 12VDC included in the set, via RF or DMX signal,
Operation Frequenz 2.4G
Dimensions: 110 x 85 x 24,2mm

3. Function/Introduction

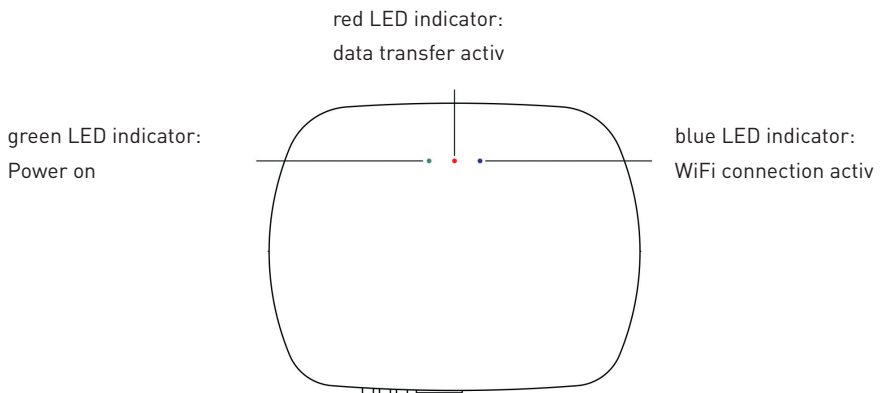

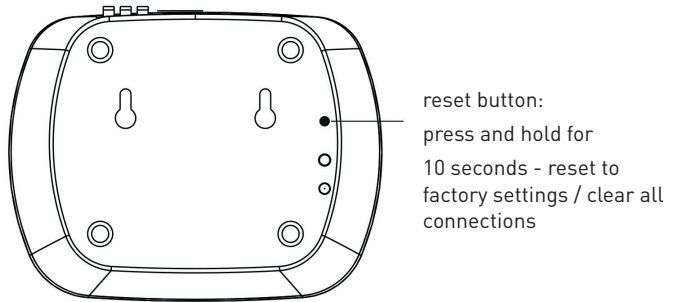
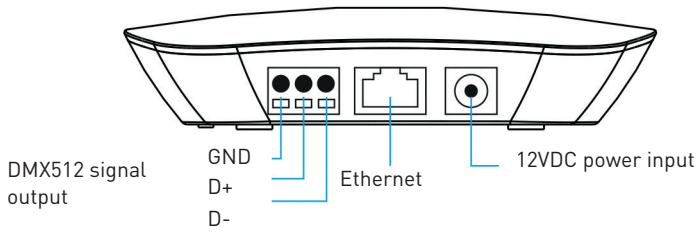

4. User Manual

There are three methods to connect the interface:

1. Connect your cell phone or tablet with the home net router (WiFi-RF)
2. Connect your cell phone or tablet with the convertor (WiFi-RF)
3. Connect your cell phone with your home net router (WiFi-DMX512)

Method 1: Connect your cell phone or tablet with the home net router (WiFi-RF)

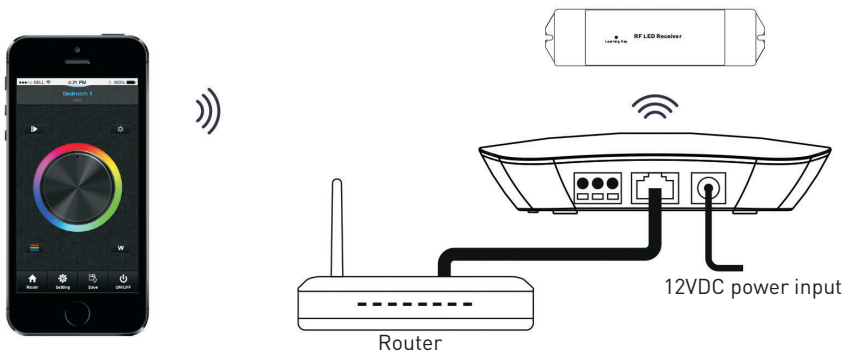

Method 2: Connect your cell phone or tablet with the converter (WiFi-RF)

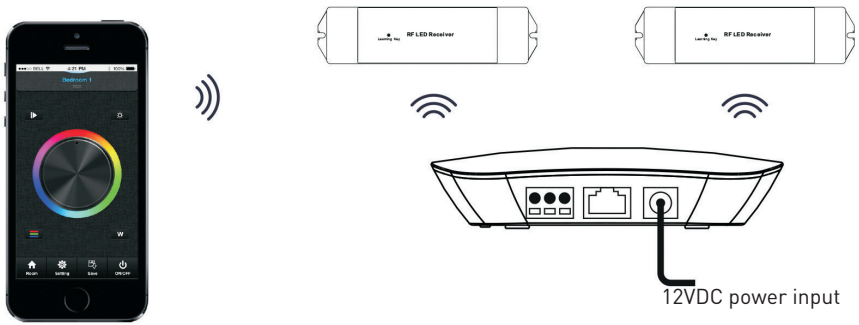

Method 3: Connect your cell phone with your home net router (WiFi-DMX512)

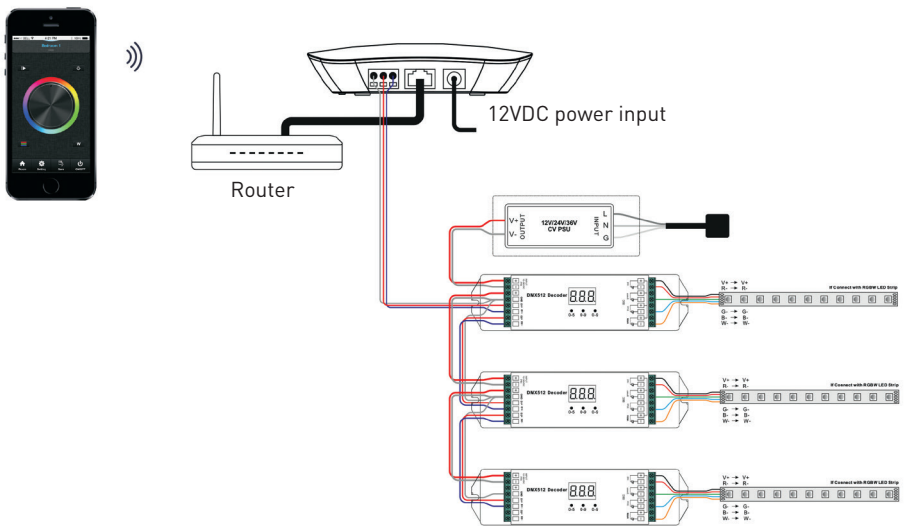

Installation of the „EasyLighting“ APP:

1. Download the application app „EasyLighting“ on your smartphone or tablet or scanning on of the below two QR Codes (Android or IOS System) to download the necessary APP:



Andriod



IOS

2. If the convertor has connected with router, then connect your cell phone to your router network. If the convertor did not connect with router, then connect your cell phone to the convertor network directly (password: 0123456789 - as per interface backside)

3. Open the easylighting application and operating according the application manual.

Set DMX Address:

Set DMX decoders address as follows for multi-zone RF remote or EasyLighting APP:

DMX decoders with address 001 will be controlled by zone 1,

DMX decoders with address 005 will be controlled by zone 2,

DMX decoders with address 009 will be controlled by zone 3,

DMX decoders with address 013 will be controlled by zone 4,

DMX decoders with address 017 will be controlled by zone 5,

DMX decoders with address 021 will be controlled by zone 6,

DMX decoders with address 025 will be controlled by zone 7,

DMX decoders with address 029 will be controlled by zone 8,

Each zone can pair endless of DMX decoders if you set the address accordingly.

5. Safety warnings

1. The product shall be installed and serviced by a qualified person.
2. Please avoid directly sun and rain/wet conditions.
3. Always be sure to mount this unit in an area with proper ventilation to avoid overhaeting.
4. Please check if the output voltage of any LED power supplies used comply with the working voltage of the product.
5. Never connect any cables while power is on and always assure correct connections to avoid short circuits before switching on.
6. Please ensure that the cable is secured tightly in the connector.
7. For update information please consult your supplier.

EasyLighting application manual:

Configure

There are two different ways to configure smart phone or tablet connect to the interface:

1. Connect WiFi LED controller to your home network
2. Use direkt EasyLighting connection with the WiFi LED controller

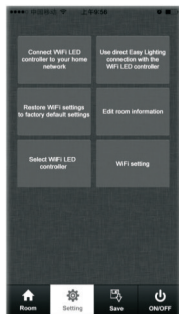

P1

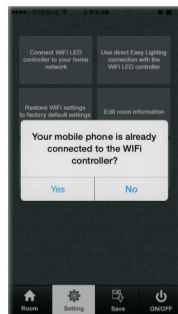

P2

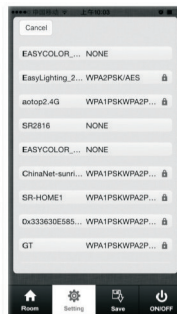

P3

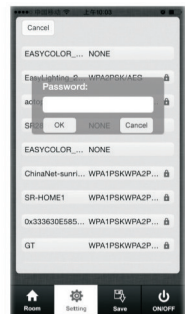

P4

Connect WiFi LED controller to your home network

Most popular way when need to control LED lighting by own house's WiFi.

- 1) Using the WiFi connection on the smartphone or tablet, locate the LED RF & DMX WiFi Interface Ethernet Controller and connect it - enter the password on the device below (factory setting password: 0123456789)
- 2) Open the EasyLighting APP
- 3) Short press the „Setting“ Button (P1)
- 4) Choose the button „Connect WiFi LED controller in your home network“
- 5) Press „Yes“, it will search all the router around automatically. (P2, P3)
- 6) Choose your home network (P3)
- 7) enter your router password and press the „OK“ button (P4)
- 8) The interface is now connected with your home network via your router.

Use direct EasyLighting connection with the WiFi LED controller

- 1) Using the WiFi connection on the smartphone or tablet, locate the LED RF & DMX WiFi Interface Ethernet Controller and connect it - enter the password on the device below (factory setting password: 0123456789)
- 2) Open the EasyLighting APP
- 3) Short press the „Setting“ Button (P1)
- 4) Choose the button „Use direct Easy Lighting connection with the WiFi LED controller“
- 5) Press „Yes“ to confirm the connection
- 6) The interface is now connected with your smartphone or tablet.

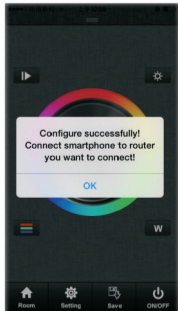

P5

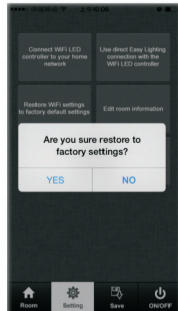

P6

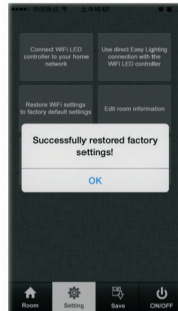

P7

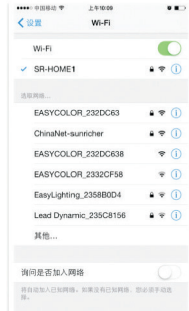

P8

Restore WiFi settings to factory default setting

When we control WiFi by exist network, the mold of WiFi controller was changed. Easilighting cannot be search in the network list unless we reset the router. Then we can use this button to restore the WiFi controller to factory setting. (This function only is use when using exist WiFi network).

- 1) Connect exist WiFi and make sure WiFi controller already be configure to this network
- 2) Open the Easylighting APP
- 3) Short press the „Setting“ Button
- 4) Choose the connection „Restore WiFi setting to factory default settings“
- 5) Press „Yes“ it will indicate successful restore factory setting (P6)
- 6) Press „OK“, after around 1 minute you will find the controller in your network list again on your smartphone or tablet.



P9



P10

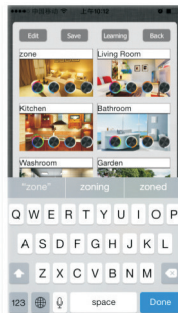

P11



P12

Room editing information

- 1) Open the Easylighting APP
- 2) Short press the „Setting“ Button
- 3) Short press „Edit room information“ there will be room editing page as (P9).

a) Edit room / zone name

- 1) Press in the Menu Room editing information the point „Edit“ on the above left side (P9)
- 2) Choose the required zone/room (for example Bedroom)
- 3) Clear the old name and enter a new name (for example zone)
- 4) Press short „Save“ Button (P11)

b) Change the picture for the room

- 1) Press in the Menu Room editing information the point „Edit“ on the above left side (P9)
- 2) Choose the required zone/room (for example Bedroom)
- 3) Camera function from smartphone or tablet will opened automatically
- 4) Take a picture
- 5) Press short „Use Photo“
- 6) Press „Save“ Button to confirm the settings

c) Edit the color wheel for corresponding LED lighting

- 1) Press in the Menu Room editing information the point „Edit“ on the above left side (P9)
- 2) In the room menu there are four different color wheels for Mono, Dynamic White, RGB and RGBW.
- 3) Cancel the mark for other three color wheels and keep one which you connected the LED (take single color as example) (P10)
- 4) Press the „Save“ Button to confirm the setting

Different zones which were edited to different color wheel cannot be choose at same time. different Zones which were edited to same color wheel or did not be edited any color wheel can be selected at same time.

Zone / Room Button

1. Press the Zone / Room Button
2. Press short in the middle of the zone / room picture
3. on the right upper side there will be a mark to confirm the selection. multiple rooms can be choose at same time
4. Press the Zone / Room Button again to confirm the „Room's“ selection.
5. Upper area will indicate rooms name we selected



P15



P16

Long press on the middle of the room picture to turn on/off the corresponding rooms/zones. There will be a red off mark  on the right upper side of the room picture when the room is switched off.

Color wheel

There will be four different color wheels we can select if we did not edit in the zone/room: Mono, DW, RGB and RGBW

1. Slide the upper areas from top to down to choose the color wheel from on to one.

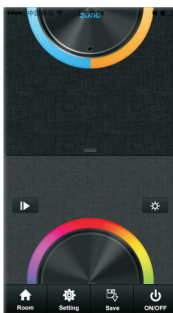

P17



P18

Press twice to get to the color wheel selection menu, where you can also select the desired color wheel.

Pause & Play Button

The Play Button only exists in RGB or RGBW color wheel interface. Press the Pause & Play button, a color begins to start, press again, it stops. Press the Pause & Play button again to start the next saved color gradient. There are a total of 10 pre-programmed color gradients stored. If you select a color while the gradient has stopped, the gradient program will start all over again.



P19

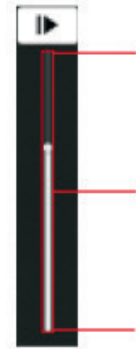

fastest speed

moving speed adjustable

lowest speed

Music



LED lighting will move according to the voice decibel nearby. Bigger decibel, faster speed. LED lighting will back to adjusted speed when no voice effected

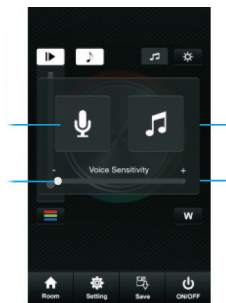

P20



LED lighting will move according to the level of music voice. Bigger decibel, faster speed.

LED lighting will back to adjusted speed when no voice effect. When choose the music button, it will open your local music player.

Highest setting requires quiet sounds to change the speedfront.



language sensitivity

Lowest setting needs loud sounds to change the speed

RGB / RGBW brightness level line

This button exists only in RGB/RGBW color wheel.

1. Short press the button 
2. Brightness level can be adjusted from 0 - 255 to an accurate color.



P21

Before adjust the color by color line, LED might in already in an existing color, so we need zero clearing each channel first: moving each channel in any level between 1-225, then move it back to zero, then RGB light will off which means zero clearing successfully.

White Button

This button only exists in RGBW channels color wheel interface to adjust white channel brightness independently.



P22



100% brightness

white channels
brightness level

1% brightness

Long press of the White (W) Button to switch the white channel ON/OFF independently.

Brightness Button

The Brightness Button exists only in DW, RGB and RGBW color wheel.

in RGB color wheel interface, it only adjusts R, G and B three channels brightness and cannot adjust W (White) channel, We need use W button to adjust W (White) channel brightness independently.



P23





100% Helligkeit

1% Helligkeit

in RGB and DW color wheel interface, it adjusts all channels brightness.

Save Button

Save:

1. Select the zone/room
2. Select a color or color moving mode
3. Short press of the Save Button 
4. long press of one of the Buttons S1-S8 
5. LED lighting will flash indicate save successfully.



P24

Recall of the saved color/color move mode over the buttons S1-S8:

1. Select the zone/room
2. Short press of the Save Button 
3. Short Press of one of the Buttons S1-S8
4. LED will indicate saved color or moving modes